



I20-T Door Phone

User Manual

Safety Notices

1. Please use the specified power adapter. If special circumstances need to use the power adapter provided by other manufacturers, please make sure the voltage and current provided in accordance with the requirements of this product, meanwhile, please use the safety certificated products, otherwise may cause fire or get an electric shock. When using this product, please do not damage the power cord, or forcefully twist it, Stretch pull or banding, and not to be under heavy pressure or between items, Otherwise may cause the power cord damage, thus lead to fire or get an electric shock.
2. Before use, please confirm the temperature and environment humidity suitable for the product work. (Move the product from air conditioning room to natural temperature, which may cause this product surface or internal components produce condense water vapor, please open power use it after waiting for this product is natural drying.)
3. Non-technical staff not remove or repair, improper repair or may cause electric shock, fire or malfunction, etc, Which can lead to injury accident, and also can cause your product damage.
4. Do not use fingers, pins, wire and other metal objects, foreign body into the vents and gaps. It may cause current through the metal or foreign body, which even cause cause electric shock and injury accident. If any foreign body or objection fall into the product please stop usage.
5. Please do not discard the packing bags or stored in places where children could reach, if children trap his head with it, may cause nose and mouth blocked, and even lead to suffocation.
6. Please use this product with normal usage and operating, in bad posture for a long time to use this product may affect your health.
7. Please read the above safety notices before installing or using this phone. They are crucial for the safe and reliable operation of the device.

Table of Content

1. Acquaint I20-T	4
1.1. I20-T Front.....	4
1.2. Key Description	5
2. Start Using	5
2.1. Connect the power supply and the network.....	5
2.1.1. Connect Network	5
2.2. Quick Setting.....	9
3. I20-T Door Phone Basic Operation	10
3.1. Answering a Call	10
3.3. End a Call.....	10
3.5. Door Open Operation.....	11
4. Page Configuration	11
4.1. Ways to configure.....	11
4.1.1.Ways to configure.....	11
4.1.2. Password Configuration.....	11
4.2. Setting via web browser.....	11
4.3. WEB Page Functional Explanation	12
4.3.1. BASIC.....	12
4.3.1.1. Status	12
4.3.1.2. Wizard.....	12
4.3.1.3. Call Log.....	15
4.3.2. Network	16
4.3.2.1. WAN Config	16
4.3.2.2. Qos Config	18
4.3.2.3. Service Port	20
4.3.2.4. TIME&DATE	21
4.3.3. VOIP	22
4.3.3.1. SIP Config.....	22
4.3.3.2. Stun Config.....	28
4.3.5. FUNCTION KEY	29
4.3.5.1. Function key	29
4.3.5.2. Door Card Setting.....	32
4.3.5.3. Call Log	33
5. Appendix	33
5.1.1.Specifications:.....	34
5.1.2. Basic Feature.....	34
5.1.3. Schematic Diagram	35
5.2、 Owner Remote Opens the Voice Access Controller by VOIP Phone	35
5.3、 Card Management	35
5.3.1 Issue Card Management	35
5.3.2Issue User Card	36
5.3.3 Delete the user card (Method 1):.....	37
5.3.4、 Add Remote Visit Data.....	38

1. Acquaint I20-T

Voice Intercom I20-T voice entrance guard is a full digital network door phone, its core part adopt Fanvil mature Voip solution (Broadcom1190 chipset), stable and reliable performance, Hands-free adopting digital full-duplex mode, Voice loud and clear; generous appearance, solid durable, easy for installation, comfortable keypad, low power consumption.

I20-T voice entrance guard support entrance guard control、Voice Intercom、keypad remote to open the door.

1.1. I20-T Front



1.2. Key Description

Key	Chinese Specification	Function
	digit keyboard	enter the password to open the door Or make a calling
	Programmable keyboard	Can be set to a variety of functions, to meet the needs of different occasions
	call status indicators	standby-light off ring-2 sec.glitter hold/be hold-1sec. Glitter communication by telephone -long bright
	power led (left)	Long bright after power supply
	Network and SIP status indicator light (right)	network failure 1 sec. glitter network normal light off registration failure 3 sec. glitter registration succeed long bright

2. Start Using

Before you start to use I20-T, please make the following installation:

2.1. Connect the power supply and the network

2.1.1. Connect Network

In prior to this step, please check if your network can work normally and have capacity of broadband internet access.

1. Broadband Router

Connect network one end with I20-T WAN port, connect the other end with your broadband router LAN port, then network hardware connection is completed. In most cases, you must set your I20-T network as DHCP mode. Please refer to the detailed setting ways **3.2.1**, set network.

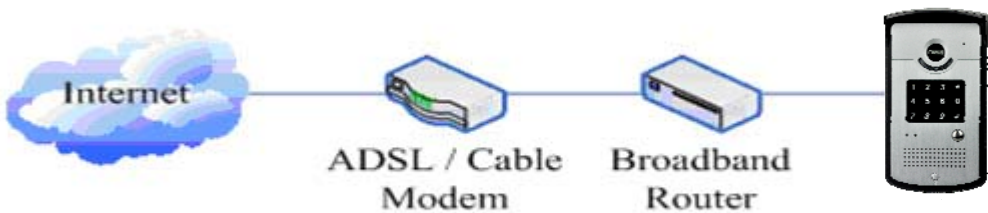

2. wireless broadband router

Connect network one end with I20-T WAN port, connect the other end with your ADSL modem LAN port, then network hardware connection is completed. In most cases, If you are using the TV cable broadband, you must set your I20-T network as DHCP mode: if you are using ADSL, then you must set your I20-T network as PPPoE mode. Please refer to the detailed setting ways **3.2.1, set network.**

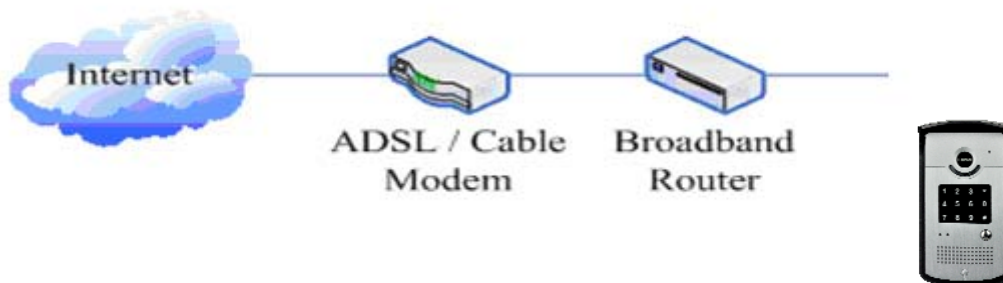

2.1.2. Interface Description

2.1.2.1 Network, Power Switch, Electric Lock Connection



CN6												
Output12V DC		Electric Lock Driver			WAN (UTP Cable Connection)							
1	2	3	4	5	6	7	8	9	10	11		
V+	GND	NC	COM	NO	POE+	POE-	TX+	TX-	RX-	RX+		
12V DC input		Normally open, normally close port										

CN7							
LAN (UTP Cable Connection)							
1	2	3	4	5	6		
4/5	7/8	TX+	TX-	RX-	RX+		

2.1.2.2 Electric Lock Connection Driver Option

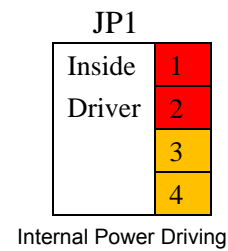
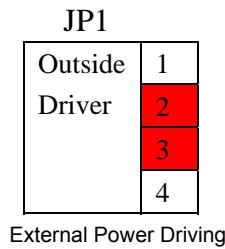

【Notice】 When the initial electric current of the lock is less than 500mA/12V, you can access to the internal driven mode and use the POE of the Voice Access System or 12V DC to control the the switch of the electric lock ; When the initial electric current of the lock is more than 500mA/12V, you need to access to the external driven mode(Use specialized DC power to control the electric lock)

2.1.2.3 Wiring

Relay connection description:

- NO: means idle-disconnected contact (normally open)
- COM: means a pin contact(middle);
- NC: means an idle-connected contact(normally close);

Electric lock supply mode		Electric lock		Jumper JP1	Mode of connection								
Internal	External	NO	NC										
√		√		<table border="1" style="margin-left: auto; margin-right: auto;"> <tr> <td>Inside</td> <td>1</td> </tr> <tr> <td>Driver</td> <td>2</td> </tr> <tr> <td></td> <td>3</td> </tr> <tr> <td></td> <td>4</td> </tr> </table>	Inside	1	Driver	2		3		4	
Inside	1												
Driver	2												
	3												
	4												

	√	√		<table border="1"> <tr><td>Outside Driver</td><td>1</td></tr> <tr><td></td><td>2</td></tr> <tr><td></td><td>3</td></tr> <tr><td></td><td>4</td></tr> </table>	Outside Driver	1		2		3		4
Outside Driver	1											
	2											
	3											
	4											
√			√	<table border="1"> <tr><td>Inside Driver</td><td>1</td></tr> <tr><td></td><td>2</td></tr> <tr><td></td><td>3</td></tr> <tr><td></td><td>4</td></tr> </table>	Inside Driver	1		2		3		4
Inside Driver	1											
	2											
	3											
	4											

Electric power mode	lock supply		Electric lock		Jumper JP1	mode of connection							
	Internal	External	NO	NC									
		√		√	<table border="1"> <tr><td>Outside Driver</td><td>1</td></tr> <tr><td></td><td>2</td></tr> <tr><td></td><td>3</td></tr> <tr><td></td><td>4</td></tr> </table>	Outside Driver	1		2		3		4
Outside Driver	1												
	2												
	3												
	4												

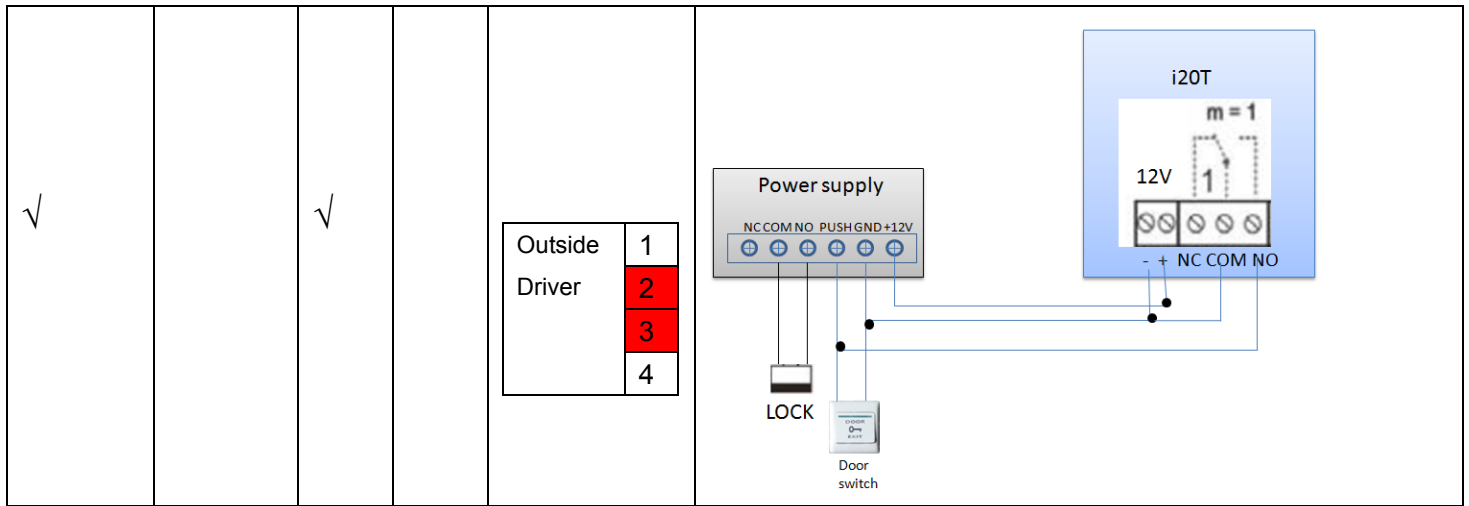

2.2. Quick Setting

I20-T Provide a complete function and parameter setting, users may need to have the network and SIP protocol knowledge for understanding the meaning represented by all parameters. In order to let I20-T users can quickly enjoy the high quality speech brought by the IP Phone services and low cost advantage, we especially lists the basic and must set options in this section, which let users can real-time started without understanding complex SIP protocols.

In prior to this step, please make sure your broadband Internet online can be normal operation, and complete the connection of the network hardware. I20-T factory default network mode is DHCP. Thus, only connect I20-T with DHCP network environment then network can be automatically connected.

1. Long press # keypad 5 Sec, then waiting for the phone play the IP address; or use [iDoorPhoneNetwork.exe](#) software to search the IP address
2. Use IP address log onto WEB server to configurate.
3. Configurate service provider supplied account on SIP page, user name, service address and other Registration required parameters.
4. Configurate shortcut key on EGS->Function key page. The advice is set to KEY EVENT type, value is OK keyboard.
5. Configurate Door Phone parameter on EGS->EGS page frame.

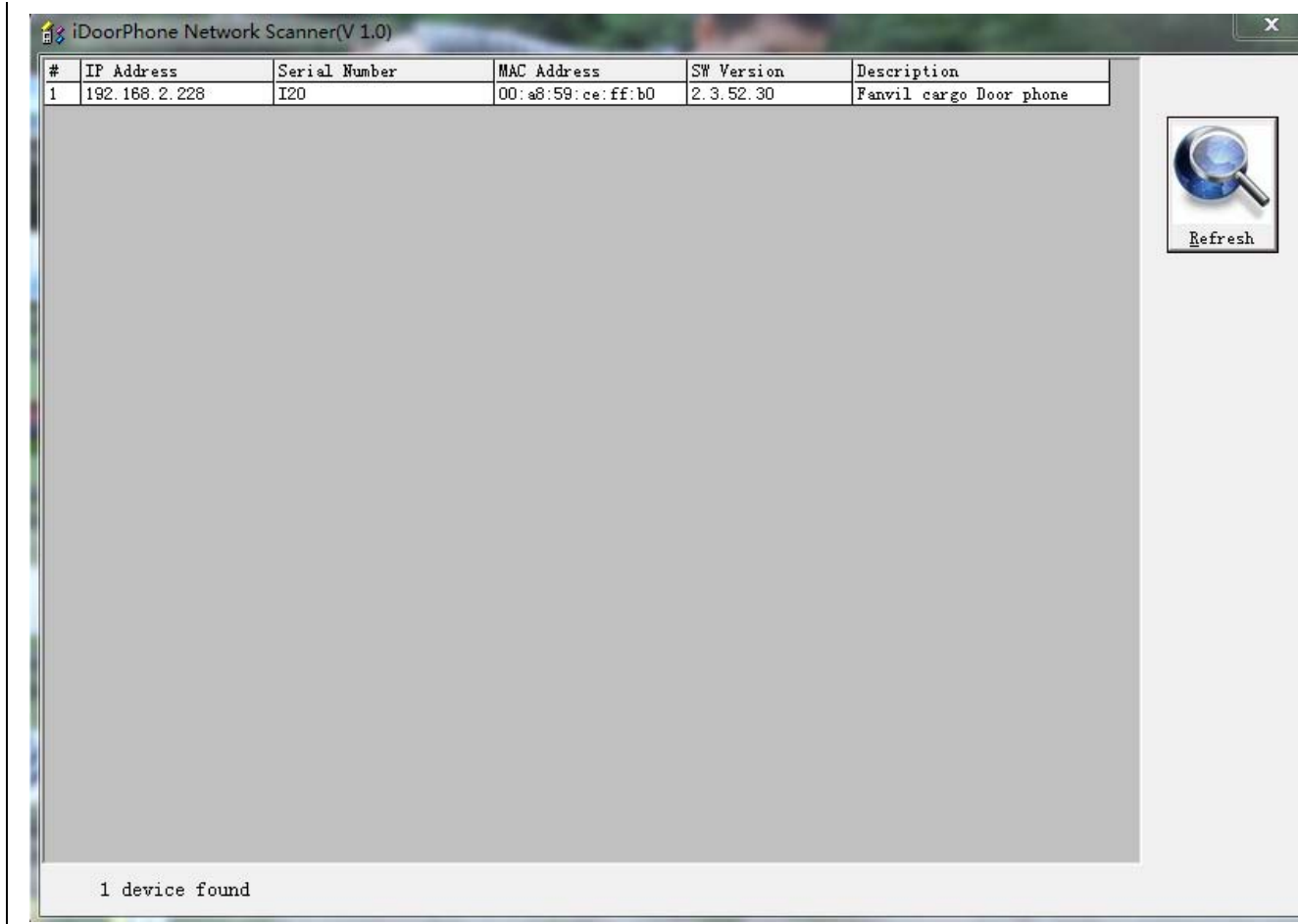

3. I20-T Door Phone Basic Operation

3.1. Answering a Call

When calling come, I20-T will ring, and configurate the shortcut as OK, then can press shortcut and answer the call.

3.2. Making a Call

- Speed Dial
Configurate shortcut as Memory key and setup a number, then press shortcut can call the configured number immediately.
- Keypad Dialing
Configurate shortcut as Dial key. Input wanted number on the keyboard then press short to call.

3.3. End a Call

Configurate shortcut as Release key to end the call.

3.4. Call Records

I20-T provides 100 missed calls、received calls、dialed Calls records, When the storage space used up, then will update the earnest records. Then the phone power of or reboot, all the call records will disappear.

Can check all these three type call records on WEB-Basic->call log page

3.5. Door Open Operation

Through the following four ways to open the door:

1. Input the local password on the keyboard to open the door.
2. The door phone call the owner, the owner enter the remote password to open the door.
3. Owner/other phone call the door, then enter the access code and remote password to open the door.
4. Use RFID to open the door.

The access code input errors by low frequency short chirp prompt to door phone and remote user.

input error will be prompted by low-frequency sirens sound.

Password input error is prompted by high frequency chirp, input successfully will be prompted by high-frequency sirens sound.

When the door opens by playing intermittent beeps for prompt. Timeout after closing door the prompt will be stoped.

4. Page Configuration

4.1. Ways to configure

4.1.1.Ways to configure

I20-T has two different ways to different users.:

- Use web browser (recommendatory way).
- Use telnet with CLI command.

4.1.2. Password Configuration

There are two levels to access to phone: root level and general level. User with root level can browse and set all configuration parameters, while user with general level can set all configuration parameters except SIP (1-2) or IAX2's that some parameters cannot be changed, such as server address and port. User will has different access level with different username and password.

- Manager mode:
 - ◆ User Name: guest
 - ◆ Password: guest
- Manager mode:
 - ◆ User Name: admin
 - ◆ Password : admin

4.2. Setting via web browser

When I20-T and PC are connected to network, input phone IP address into Internet Explorer(IP address can obtain via pressing sysinfo key) http://xxx

.xxx.xxx.xxx/, (if the web log on port is not 80 standard port, then need input http:

//xxx.xxx.xxx.xxx: xxxx/, otherwise it will show can not find a server

)You can see the web management interface login screen (as below image) . Enter the user name and password and click on the **【Logon】** button then can enter into the set menu.

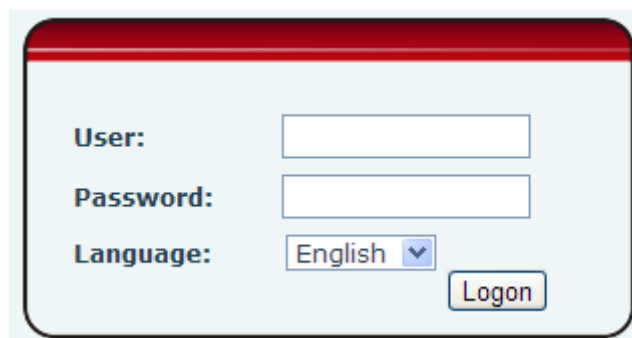

※:If you do not save the settings you changed, next power boot it will back to the previous state unchanged. If you want to save the settings, after you made the change, please click Maintenance-Config-save then all are saved, in the process, the phone will immediate effect without reboot.

4.3. WEB Page Functional Explanation

4.3.1. BASIC

4.3.1.1. Status

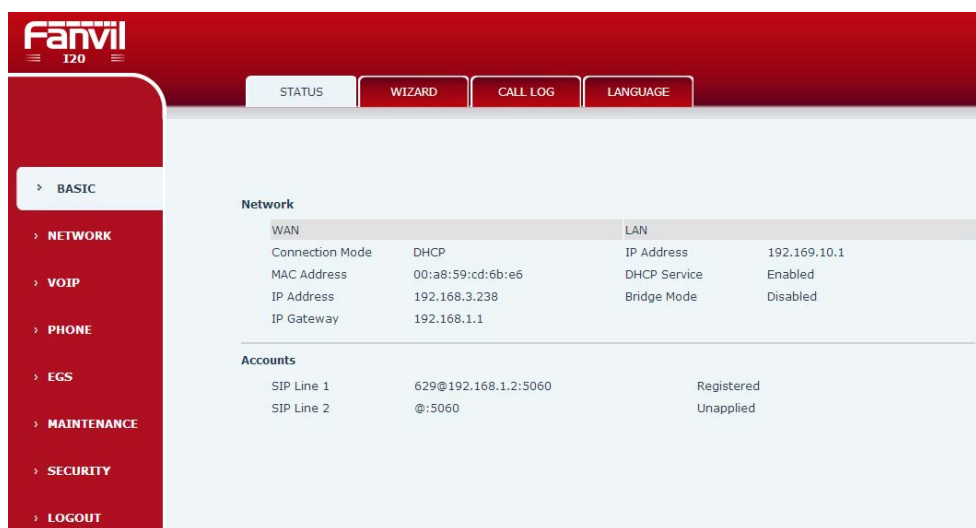

Status	
Field Name	Description
Network	Shows the phone current WAN configuration: include WAN IP get way (Static、DHCP、PPPoE) and MAC address, IP, the default gateway IP address
Accounts	Shows the phone current SIP LINE 1—2 registered and the corresponding number status. The bottom of the page shows I20-T version number and release date.

4.3.1.2. Wizard

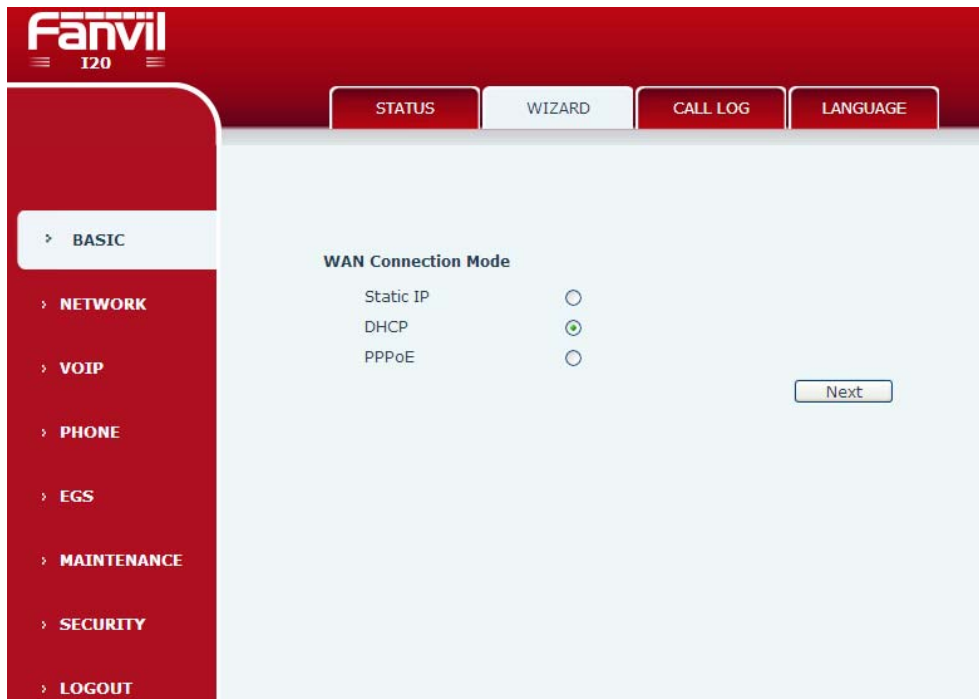

Wizard	
Field Name	Description
	<p>Telephone network on-line mode, please according to the actual network environment, select the appropriate network model. This phone provides three kinds of network online ways:</p> <p>Static : If your ISP Services provide you with a fixed IP address, you can choose this. After selecting, you must fill the Static table with: IP Address / Netmask / Gateway / Primary DNS and other related information. If you don't know the information, please ask your ISP service provider or network management personnel for assistance.</p> <p>DHCP : in this mode, network information will get automatically from the DHCP server, you need not to manually enter these fields.</p> <p>PPPoE: select this mode. you must enter the ADSL online account and password.</p> <p>You can also reference 3.2.1 Network Settings, and set your network quickly.</p> <p>Select Static IP MODE, click 【NEXT】 can simply configure the network address and SIP parameters (default as 1 Line) and browse configuration items. Click 【BACK】 return to the last page.</p>

Static IP Settings

IP Address

Subnet Mask

IP Gateway

DNS Domain

Primary DNS

Secondary DNS

IP Address	Please enter your assigned IP addresses.
Subnet Mask	Please enter your assigned subnet mask.
IP Gateway	Please enter your assigned a default gateway address.
DNS Domain	Set the DNS domain suffix. When the user input in the DNS domain name address and cannot be resolved, telephone will add this domain behind the domain name address then go to resolve.
Primary DNS	Please enter your primary DNS server address.
Secondary DNS	Please enter your alternate DNS server address.

Quick SIP Settings

Display Name

Server Address

Server Port

Authentication User

Authentication Password

SIP User

Enable Registration

Display Name	Configure display name, able to do when calling in the called party (don't name the caller) can show this configuration parameters, and allow input English letters;
Server Address	Configure the SIP registration server address,Support domain address
Server Port	Configure the SIP registration server signaling port
Authentication User	Configure the SIP registration account.
Authentication Password	Configure the SIP registration account password.
SIP User	Configure the number registered on IP server.
Enable Registration	Configurate to allow/prohibit the registration;

WAN

Connection Mode Static IP
 Static IP Address 192.168.1.114
 IP Gateway 192.168.1.1

SIP

Server Address 192.168.1.2
 Account 4113
 Phone Number 4113
 Registration Enabled

Show your manual configuration details.
 Select DHCP MODE, click **【NEXT】** can simple SIP parameter (defaulted as 1 line)
 And browse configuration items. Click **【BACK】** return to the last page, specific
 operation same as Static IP MODE.
 Select PPPoE MODE, click **【NEXT】** can simply configurate online account and
 password and SIP parameter (defaulted as 1 line) and browse configuration items.
 Click **【BACK】** return to the last page, specific operation same as Static IP
 MODE.

PPPoE Settings

Service Name
 User
 Password

Server name	service name, e.g. PPPoE service provider has no special requirements, the name as the default value is ok.
User	Please enter your ADSL account.
Password	Please enter your ADSL password.

Note: After the above operation is completed please click **【Finish】** button, The phone will automatically save the current configuration and reboot, After the successfully reboot can use the registered account to make calls.

4.3.1.3. Call Log

Through this page can check all call out record.

Call Information

Start Time	Duration	Peer Calls	Type
August 09 13:35	0 second(s)	4223 SIP1	Placed

Call Log

Field Name	Description
Start Time	The call log start time.
Duration	The call records of talk time.
Dialed Calls	This call log is the account of other side and call protocol and using line.
Type	Placed(answered),Missed (missed) ,Received (incoming).

4.3.2. Network

4.3.2.1. WAN Config

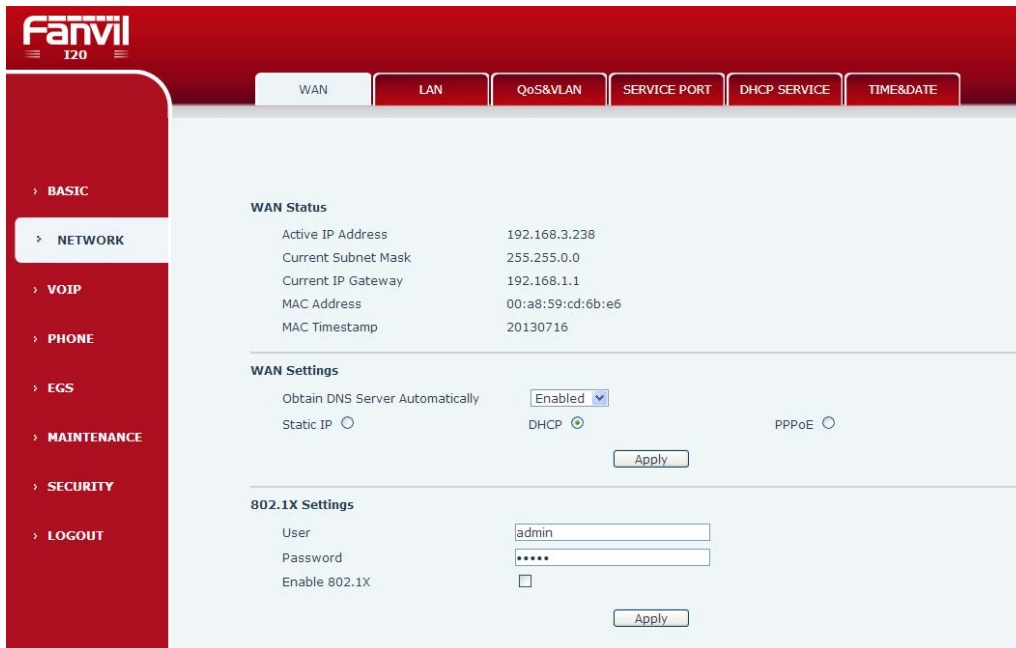

WAN Config	
Field Name	Description
WAN Status	
Active IP Address	192.168.1.12
Current Subnet Mask	255.255.255.0
Current IP Gateway	192.168.1.1
MAC Address	00:02:5f:00:00:21
MAC Timestamp	2012-3-1
Active IP Address	The phone current IP;
Current Subnet Mask	Subnet Mask;
Current IP Gateway	The current default gateway IP;
MAC Address	MAC address;
MAC Timestamp	Show the time of getting MAC address
WAN Settings	
Obtain DNS Server Automatically	Disabled
Static IP	<input type="radio"/>
DHCP	<input checked="" type="radio"/>
PPPoE	<input type="radio"/>
Apply	

Telephone network on-line mode. Please according to the actual network environment, choose a suitable network mode. This phone provides three ways for network online:

- static : If your ISP services provide you with fixed IP address, then you can choose this item. After choosing, you must fill it into Static table: IP Address / Netmask /Gateway / Primary DNS and other related information.If you don't know these information, can ask assistance from your ISP provider or network management personnel.
- DHCP : in this mode, network information will automatically obtain from DHCP server, you need not to manually enter these fields.
- PPPoE: when select this mode, you must enter the ADSL online account and password.

You can reference **3.2.1 Network Settings**, set your network quickly.

IP Address	<input type="text" value="192.168.1.114"/>
Subnet Mask	<input type="text" value="255.255.255.0"/>
IP Gateway	<input type="text" value="192.168.1.1"/>
DNS Domain	<input type="text"/>
Primary DNS	<input type="text" value="202.96.134.133"/>
Secondary DNS	<input type="text" value="202.96.128.68"/>

Only the phone used in Static mode which need set.

IP Address	Please enter your assigned IP addresses.
Subnet Mask	Please enter your assigned subnet mask.
IP Gateway	Please enter your assigned a default gateway address.
DNS Domain	Set the DNS domain suffix. When the user input in the DNS domain name address and could not resolute, after put this domain behind the domain name address then the phone will go to resolve.
Primary DNS	Please enter your DNS service address.
Secondary DNS	Please enter your spare DNS service address.

Service Name	<input type="text" value="ANY"/>
User	<input type="text" value="user123"/>
Password	<input type="password" value="••••••••"/>

Only when the phone use PPPoE mode need to set.

Server Name	service name, e.g. PPPoE Service provider has no special requirements, this name can be treated as default value.
User	Please enter your ADSL account.
Password	Please enter your ADSL code.

Note:

- 1) After setting the parameters,need click “apply”to make it effective.
- 2) f changed IP, web page must have no longer responding, at this time should enter the new address in the address bar can be connected to the

phone.

3) If system boot and use DHCP to get IP, and DHCP server network address are the same with system LAN network address, then after server get DHCP IP, add 1 to the last of LAN network address, meanwhile modify LAN DHCP Server allocate IP address field; After system reboot, WAN access DHCP log on, and DHCP server provided network address is the same as LAN provided, then WAN will not be able to get IP access networks.

4.3.2.2. Qos Config

I20-T Terminal system support 802.1Q/P protocol, support DiffServ configuration. Meanwhile, VLAN function can configurate Voice VLA and Data VLAN use different VLAN I. System configuration Data VLAN, can process the signalling, Audio stream and system and other data stream with different VLAN ID, which let the applications of VLAN is more flexible. (Below chart is helpful for your understanding the VLAN using advantages.)

Do not use VLAN

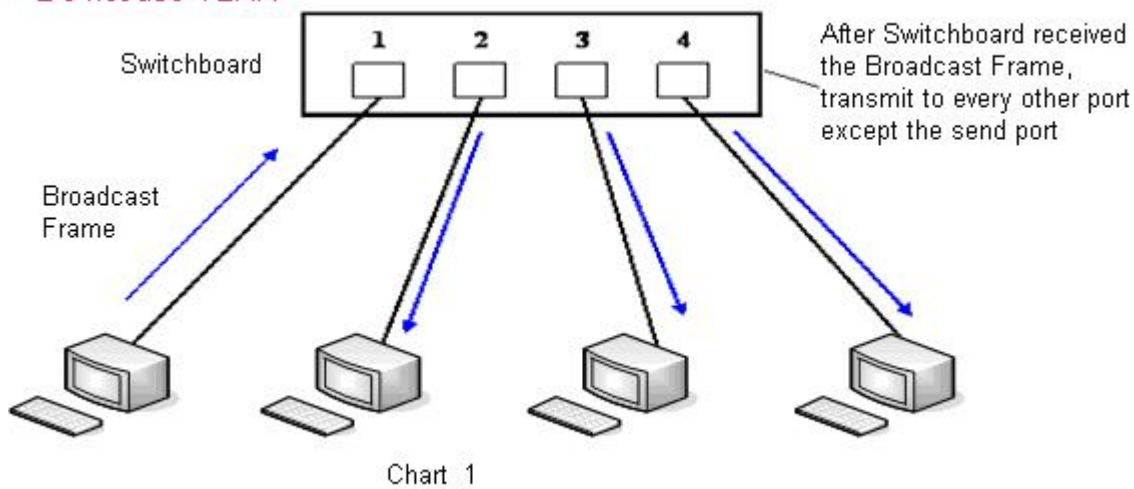

Use VLAN

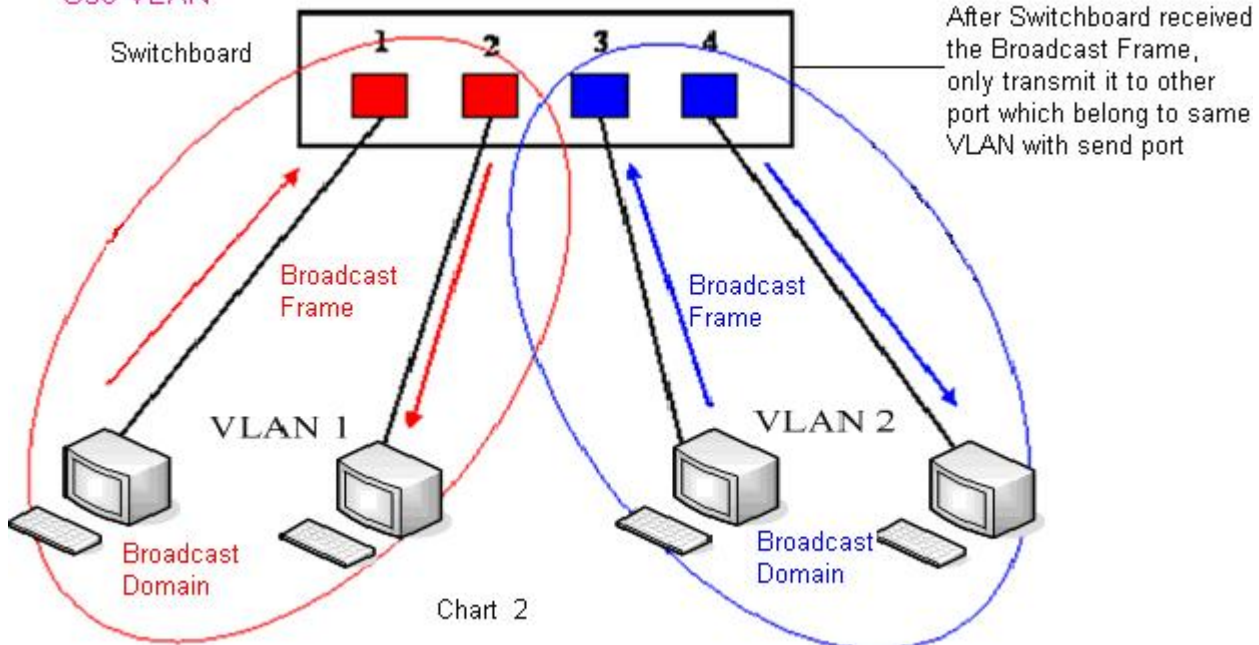

In chart

1, on a two layer switch which not set VLAN, any radio frame is forwarded to all the other ports in addition to receiving port. e.g, PC A (port 1) After sending the broadcast information, will be

forwarded to the port 2、3、4.

In chart 2, the switch generate red and blue VLAN; Meanwhile set port 1、2 as red VLAN、 port 3、4 are VLAN. Then A (port 1) send out broadcast frame, switches only will forward it to other port belongs to a VLAN——port 2 which also belong to red VLAN, Will not be forwarded to the blue port VLAN. As well, C (port 3) send out broadcast frame, Will only be forwarded to other belong to the blue port VLAN, Will not be forwarded to belong to the red VLAN ports.

In this way, VLAN by limiting the broadcast frame forwarding range to partition the broadcast domain. In the above chart for better illustration, use red, blue two colors to identify different VLAN, in the practice is using "VLAN ID" to distinguish.

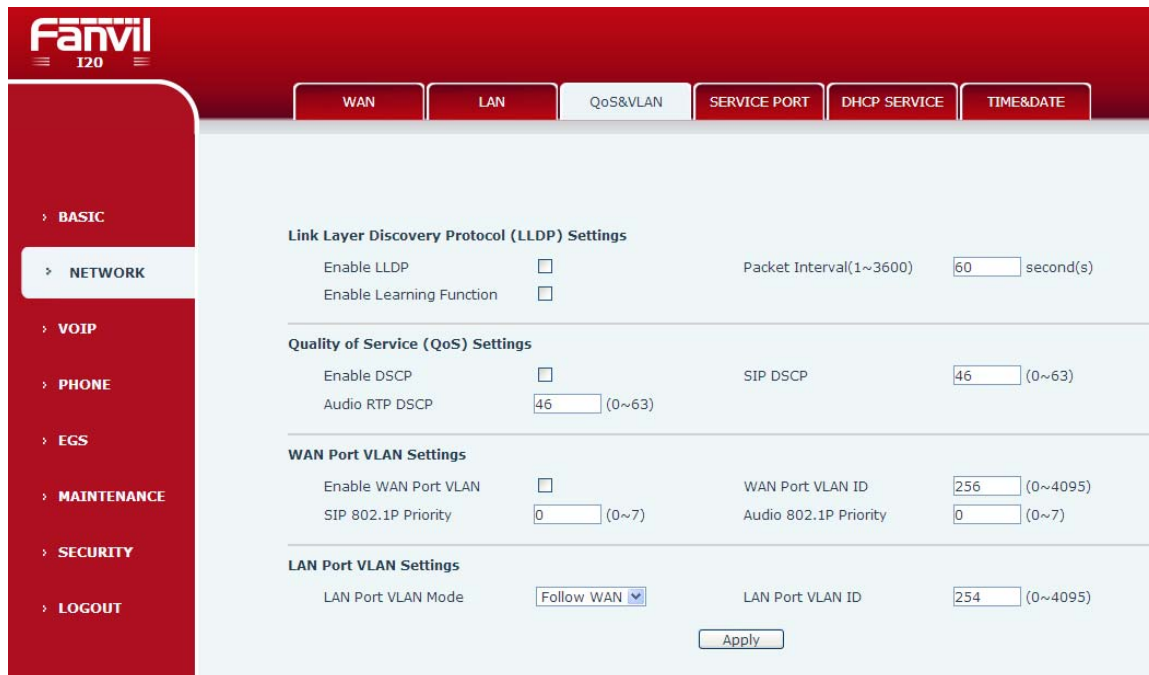

Field Name	Description
LLDP Setup	
Open LLDP	Open the phone LLDP Message function
Open Learning Function	Open phone learning LLDP function , After the opening , phone will automatically learn QoS in switch , VLAN ID, 802.1p,etc.configuration value.If different, phone will Automatically updated to the value in switch, synchronization with switches.
Data sending interval	The interval of phone sending data , the unit is second.Default it is 60 seconds.
QOS Setup	
Open DiffServ	Configurate whether open DiffServ
Signal Dscp	Configurate the value of Signal Dscp
Voice Dscp	Configurate the value of Voice Dscp
WAN VLAN Setup	
Open WAN Port VLAN	Open the VLAN of WAN port

WAN Port VLAN ID	Configurate ID value of VLAN, range is 0-4095
Signal 802.1P Priority	Configurate the value of Signal 802.1P, range is 0-7
Voice 802.1P Priority	Configurate the value of Voice 802.1P, the range is 0-7
LAN VLAN Setup	
LAN Port Vlan	Open/forbid Port Vlan Same as WAN port ID value Close:Disable Port Vlan Open: after open it then input different ID value from WAN port
LAN Port VLAN ID	Setup ID value of VLAN, range is 0-4095

4.3.2.3. Service Port

Through this page can set Telnet ,HTTP,RTP port.

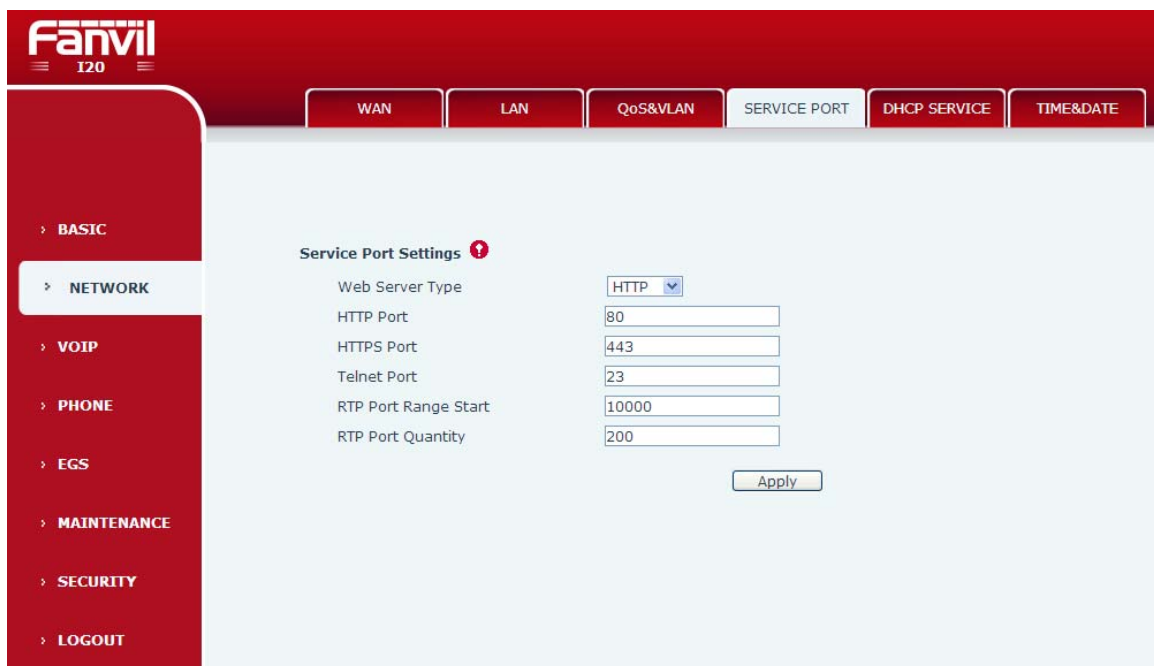

SERVICE PORT	
Field Name	Description
HTTP Port	Configurate web browser port, default 80 port, if want to enhance system security, can modify it to non-80 standard port, save the data after modification, when lo in again please use this way: http://xxx.xxx.xxx.xxx: xxxx.
Telnet Port	Configurate telnet port, default 23port;
RTP Port Range Port	Configurate phone RTP and open the starting port.Allocate this port as dynamic allocation;
RTP Port Quantity	Configure the phone allocation RTP port Max quantity . Default 200 pieces;
Notice: 1)After modifying this page need to save and reboot the phone which can make it come into force.	

- 2) If change Telnet ,HTTP port number , it's better set bigger port number than 1024, because 1024 port is system reserved port.
- 3) HTTP port number is set as 0, then forbid the HTTP service.

4.3.2.4. TIME&DATE

According to their own position、 configuration time zone and SNTP Server to automatically obtain time and daylight saving time function, can also according to their need to manually adjust the time.

SNTP	
Field Name	Description
SNTP Time set	
SNTP	Configurate whether enable SNTP server
DHCP Time	Whether use DHCP dynamic to obtain time, after enabling, phone will synchronization network time automatically in certain time
Main Server	Configurate phone obtain current time SNTP main server address.
Backup Server	Configurate phone obtain current time SNTP backup Server address.
Territory	Configure the choice for time zone

Synchronous Query	inquiry from the server constantly to synchronize , default 60 second
12 hours system	System can switch to 12 hours, default is 24 hours
Date Format	Configure date format
Date Separator	Configure date separator
summer time set	
Open the Daylight Saving Time	Configure the daylight saving time
Time Change Length(Minute)	Configure the daylight saving time changing length
Month	Configure DST the starting month and end month
Week	Configure DST the starting week and end week
Date	Configure DST the starting date and end date
Hour	Configure DST the starting hour and end hour
Minute	Configure DST the starting minute and end minute
Manually set the time	
Manually set the time, need firstly disable SNTP service, in the above chart year、month、date、minute、hour、second every part need filled into and submit then manual set will succeed.	

4.3.3. VOIP

4.3.3.1. SIP Config

Configure the SIP server here.

SIP Config	
Field Name	Description

Choose which line configuration of the SIP account, There are two lines to choose from. Select and click 【Load】 switch to the line account configuration	
Basic setup	
registration status	Phone SIP registration status display; if the register will show the registered successfully, Otherwise is unregistered
server name	Name the server
Server Address	Configure SIP register server address,support domain form address
server port	Configure SIP register server signaling port
user name	Configure SIP registration account
Password	Configure SIP registration account password
Telephone number	Configure the number registered to the SIP server, if it is empty, then it is not a registered
Display Name	Configure display names, able to do when calling in the called party (not name the calling party) can show this configuration parameter, allow input English letters
Proxy server address	Configure proxy server IP address (generally, SIP service provide users the use proxy server and register the same server configuration to provide services, thus, the proxy server configuration is usually is the same as the registered server configuration,if the service providers give different registered server from the proxy server IP address configuration , need modify their server configuration)
proxy server port	Configure SIP proxy server signaling port
proxy server account	Configure proxy server account
proxy server password	Set the proxy server password
local domain name	Configure the SIP local domain name. If the server does not require a local domain name to specify the domain name for a SIP terminal, the local domain can be configured with the same address or domain name server.System to simplify the user input, users can not enter the local domain name, the system will automatically get registered address fill in the content of domain realm.
backup proxy server address	Configure the backup proxy server address, if the master agent server address is unavailable, phone will enable backup proxy server address automatically
backup proxy server port	Configure the backup proxy server port

Open registration	Configure allow/prohibit registration
Codecs	
Disable Codecs/Enable Codecs	According to the need by navigation on Disable Codecs/Enable Codecs list add or remove coding, and can be used by the priority of the up and down navigation keys to change the coding.
Advance SIP configuration	
Forward Type	<p>Choose call forwarding way. call forwarding (default it's close)</p> <ul style="list-style-type: none"> ● close: close call forwarding function ● busy: incoming calls when the phone is busy directly forwarded to the specified number ● No answer : incoming calls within a specified time has not been answered, then forwarded to the specified number ● all the time: incoming call will be transferred to the specified number before directly before the forwarding operation, machine indicates the caller id
Forward Number	configure forward number
Call Forward No Answer Delay Time	If it's call forward no answer, if nobody answer incoming call in Call Forward No Answer Delay Time then the calling will be forwarded to specified number
Transfer timeout	For the phone supports the transfer of certain special features server, set interval time between sending "bye" and hanging up after the phone transfers a call.
Enable the hot line number	Configure to enable the hotline number
Hot line number	Specify Hot Line Number, the phone dial the hot line number automatically at hands-free mode or handset mode after warm line time.
Hot line delay time	Configure hot line delay time
Open signal encryption	Configure whether to support signaling encryption
Signal encryption key	Input signal encryption key
Open voice encryption	Configure whether to support voice encryption
Voice encryption key	input speech encryption key
Open the automatic reply	Configure automatic reply

Automatic response time	When there is a call in, and over time went unanswered, phone will answer it automatically
Open dialogue timer	Configure whether to support rfc4028, refresh the SIP sessions
Dialogue timeout	Configure dialogue timeout
Open subscription MWI	Subscribe information after a successful registration, can subscribe others' status or voice mails, and so on.
Voicemail Number	Configure MWI number, realize sip voice message inform and listen to voice message. When there is a new voice message, voicemail will flashing lights, pick up and press MWI key will automatic call to voicemail, and listen to the voice mail, If no new message, voicemail light is out
Subscribe the packet retransmission timeout	Configure subscription time interval
Meeting Type	Specify the Conference Type, if you select the local, you needn't input the conference number.
meeting room number	Configure meeting room number, please contact your service provider to the meeting room number
Registration Expire	Set expire time of SIP server register, default is 60 seconds. If the register time of the server requested is longer or shorter than the expired time set, the phone will change automatically the time into the time recommended by the server, and register again.
Enable Service Code	Configure whether enable service code
DND On Code	Set the DND On Code, When you press the DND hot key, the phone will send a message to the server, and the server will turn on the DND function. Then any calls to the extension will be rejected by the server automatically. And the incoming call record will not be displayed in the Call History.
DND Off Code	Set the DND Off Code, When you press the DND hot key, the phone will send a message to the server, and the server will turn off the DND function
Always CFwd On Code	Set the Always CFwd On Code, when you choose to enable the always forward function on your phone, it will send message to the server, and the server will turn on the function immediately. When there are calls to the extension, the server will always forward it to the set number automatically. And the IP phone will not show the record in the call history anymore.
Always CFwd Off	Set the Always CFwd Off Code, when you choose to

Code	disable the always forward function on your phone, it will send message to the server, and the server will turn off the function immediately.
Busy CFwd On Code	Set the Busy CFwd On Code, when you choose to enable the busy forward function v on your phone, it will send message to the server, and the server will turn on the function immediately. When there are calls to the extension, the server will forward it to the set number automatically based the forward type. And the IP phone will not show the record in the call history anymore.
Busy CFwd Off Code	Set the Busy CFwd Off Code, when you choose to disable the busy forward function on your phone, it will send message to the server, and the server will turn off the function immediately.
No Answer CFwd On Code	Set the No Answer CFwd On Code, when you choose to enable the on answer forward function on your phone, it will send message to the server, and the server will turn on the function immediately. When there are calls to the extension, the server will forward it to the set number automatically based the forward type. And the IP phone will not show the record in the call history anymore.
No Answer CFwd Off Code	Set the No Answer CFwd Off Code, when you choose to disable the busy forward function on your phone, it will send message to the server, and the server will turn off the function immediately.
Anonymous On Code	Set the Anonymous On Code, When you choose to enable the anonymous call function on your IP phone, it will send information to the server, and the server will enable the anonymous call function for your IP phone automatically.
Anonymous Off Code	Set the Anonymous Off Code, When you choose to disable the anonymous call function on your IP phone, it will send information to the server, and the server will disable the anonymous call function for your IP phone automatically.
Server Detection Type	Configure server detection type, if it's option, phone will send option SIP message to server every configured time , server respond 200OK to maintain server detection. If it's UDP,phone will send option UDP message to server every configured time
Server detection time interval	Configure Server detection time interval, if phone enable SIP server detection function, phone will to test whether a server response every configured time

User Agent	User Agent Terminal
DTMF Type	Set DTMF sending mode, there are three: <ul style="list-style-type: none"> ● DTMF_RELAY ● DTMF_RFC2833 ● DTMF_SIP_INFO Different VoIP Service providers may provide different modes.
Local Port	Set sip port of each line.
Ring Type	Set ring type of each line.
Enable Via rport	Enable/Disable system to support RFC3581. Via rport is special way to realize SIP NAT.
Enable PRACK	Enable or disable SIP PRACK function, suggest use the default config.
Enable Long Contact	Set more parameters in contact field; connection with SEM server.
Convert URI	Convert # to %23 when send the URI.
Dial Without Registered	Set call out by proxy without registration;
Ban Anonymous Call	Set to ban Anonymous Call;
Enable DNS SRV	Support RFC2782;
Server Type	Select the special type of server which is encrypted, or has some unique requirements or call flows.
RFC Protocol Edition	Select SIP protocol version to adapt for the SIP server which uses the same version as you select. For example, if the server is CISCO5300, you need to change to RFC2543; else phone may not cancel call normally. System uses RFC3261 as default.
Transport Protocol	Set transport protocols, TCP or UDP
Anonymous call Specification version	Set Anonymous call out safely; Support RFC3323and RFC3325;
Keep Authentication	Enable/Disable Keep Authentication System will take the last authentication field which is passed the authentication by server to the request packet. It will decrease the server's repeat authorization work, if it is enable.
Enable Click-to-Call	Configure Click-to-Call ; (Need the actual software application support)
Only respond to a speech codec	When it is called,only respond to one supported Codec
Auto TCP transfer	Set to use automatically TCP protocol to guarantee usability of transport as message is above 1300 byte
Configure Compatible with special server	Compatible with special server (Support the special SIP server-when phone receives the packets sent from server,phone will use the source IP address, not the address in via field.)
Enable GRUU	Set to support GRUU

Enable Display name Quote	Set to make quotation mark to display name as the phone sends out signal, in order to be compatible with server.
Enable user=phone	Enable user=phone by selecting it, it is contained in the invite sip message, in order to be compatible with server.
Enable Missed Call Log	Enable the missed call log by it, the phone will save the missed call log into the call history record and display the missed calls on the idle screen, or won't save the missed call log into the call history record and display the missed calls on the idle screen.
Enable BLF List	Configure BLF List, BLF List can monitor the state of multiple accounts.
BLF List number	Configure BLF List number
SIP Global Settings	
Strict matching Branch field	Enable the Strict Branch, the value of the branch must be in the beginning of z9hG4k in via field of the invite sip message received, or the phone won't response to the invite sip message. Notice: the deployment will become effective in all sip lines.
Enable Group function	Enable Group by selecting it, then the phone enable the sip group backup function. Notice: the deployment will become effective in all sip lines.
Registration Failure Retry Time	Specify the registration failure retry time, if the phone register failed, the phone will register again after registration failure retry time. Notice: the deployment will become effective in all sip lines.

4.3.3.2. Stun Config

In this web page, you can config SIP STUN.

STUN: By STUN server, the phone in private network could know the type of NAT and the NAT mapping IP and port of SIP. The phone might register itself to SIP server with global IP and port to realize the device both calling and being called in private

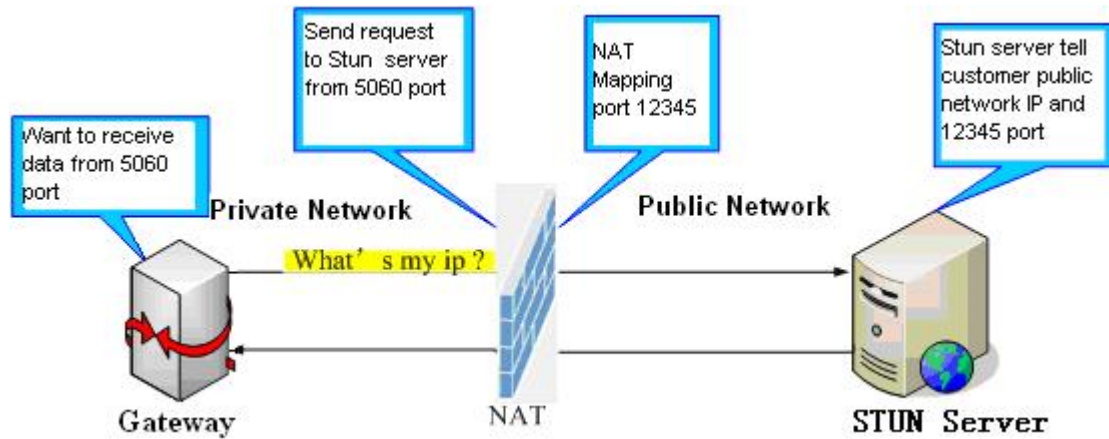

network.

4.3.5. FUNCTION KEY

4.3.5.1. Function key

1-4 programmable key in phone software(depend on hardware),you can configurate different feature on each key. You can ref to below indications for each feature, default is NA, means without any feature settings.

FUNCTION KEY DOOR PHONE Door Card Door LOG

FUNCTION KEY Settings

Key	Type	Number 1	Number 2	Line	Subtype
DSS Key 1	Hot Key	605	600	SIP1	Speed Dial
DSS Key 2	None			SIP1	None
DSS Key 3	None			SIP1	None
DSS Key 4	None			SIP1	None

Apply

1) Type=Hot key

Number 1/2 is the fixed phone number, when press the DSS key, the phone call the fixed phone number. this phone number can also be set as IP address.

2) Type=Key Event

You can set type as key event, there're many options in the subtype for your selection.

- None
- Dial
- Release
- OK

3) Number Setting

Number1 and number2 is 2 different calling number, when the Dial Mode is <Main-Secondary>,

Number1 is the Main number and Number2 is the secondary number; When the Dial Mode is <Day/Night>, Number1 is the daytime period and Number2 is the night time period

EGS

EGS, to config the door phone and maintenance the visitor data

Voice Access Configuration		
Setting Item	Function	Initial Value
Open Time	Time for open the door, if time is up, the door will be closed automatically.	5s
Holding Time	After time is up, the call will be ended automatically.	120s
Remote Openig Time	Remote opening password.	*
Local PIN	Local password for the keypad	6789
Tone settings	Mute/Short beeps/Long beeps	Bell ringing
Keypad mod (i20T Valid)	Password only(Prohibit call)/Password-Dial	Dialing and password input
Description	Displayed on iDoorPhoneNetworkScanner software	i20 IP door phone
Remote phonebook settings	Enabling access phone: when remote phone calls, input access code first then input password to open the door. Disabling access phonebook: when remote	Enable

	phone calls, input password only.	
Enable Touchpad	Provide keyboard function	open
Enable Card Reader	Provide card reader function	open
Dial Mode Select	<Primary /Secondary>mode corresponds to the first number in one-button Call function, <Day/Night>mode corresponds to the second number in one-button Call function	Primary /secondary
Time of Switch	The period between one-button Call function to call the first and second number	16s
Day Start Time	When select <Day/Night>mode, the time to start Day time	06:00
Day End Time	When select <Day/Night>mode, the time to end up Day time	18:00
Address of Log Server	Log server address (IP)	
Port of Log Server	Log server port (0-65535, default:514)	
Enable Log Server	Enable or Disable the log server	Disable
Enable Indoor Open	Use to disable or enable the indoor open function	Disable
Remote Phonebook		
Number	Remote phone number	
Authentication code	Access code for visitor. When remote phone calls, if the number is in access list, you can input access code to open the door.	When IP phone calls, it needs to input authentication code to control voice access controller.
Type of Host	When owner calls, controller answer automatically, when visitor calls, controller mute.	
Name	Card holder's name	
Position	Card holder's position	
Department	Card holder's department	
Card number	RFID's number	

To add new visitor, add the visitor number in <Number> and <Access Code>; Visitor's Name, Position and Department is optional; And then Select the ID (Card number) and Access Type (Visitor or Owner). Press <Add> key to add new visitor. The visitor can call the door phone and input the access code to open the door or use ID card to open the door. Maximum 100 visitors

To modify visitor data, click <Delete> or <Modify> key to delete/modify the visitor data, all data can be modified except calling number

After you set the log server, i20T will send log data to the log server.

Data format:

<8>MAR 20 11:17:38 5,0003476426, IC Card, I20 IP Door Phone

[Note]:

- “<8>” :log level
- “MAR 20 11:17:38” : happen time
- “5,0003476426, IC Card, I20 IP Door Phone” :logs have include door open time ,Card number/phone number ,open door type ,device.

4.3.5.2. Door Card Setting

Door Card Setting,to config the ID card and admin the card issue and delete

Door Card Setting	
Code	Explanation
State	ID Card Status Setting: Normal Status, Wave card to open the door Card Issuing Status, Update the ID card data to phone database Card Revoking Status, Delete the ID card data from the database
Administrator Table	Administrator data table, display the administrator ID, Date and Type
Add Administrator	Add Administrator, Admin Card Number, Type, Card Issuer and Revocation. When the ID Card status is in <Normal>,wave admin card to enter

	card issuing mode, and then wave the additional cards into the database, when the procedure completed, wave admin card again to enter Normal status.(Delete card procedure is same),Maximum 10 Admin Card and 100 visitor card
Delete Administrator	To delete Admin Card, select the card number and click<delete>
Door Card Table	ID card database, display the card number and Issuing Date

4.3.5.3. Call Log

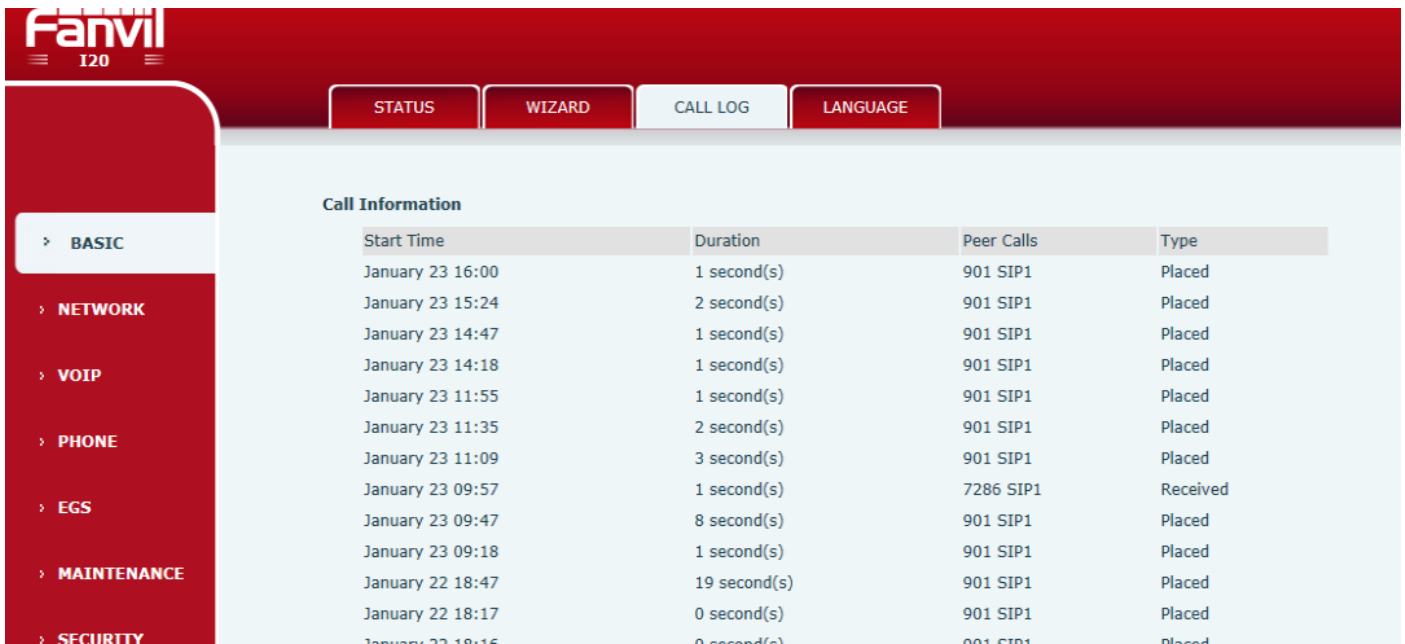

Display call history,Maximum 2000 call history,the earliest exceeded call history will be deleted automatically.Right-Click to export Call Log in CSV format

Call Log	
Code	Explanation
Start Time	Time for door opening
Duration	Door Opening Duration time
Peer Calls	Caller ID(Remote Opening),Card ID number(IC card),N/A(local)
Type	Door opening type: Local, Remote, IC card

5. Appendix

5.1.1.Specifications:

	Protocol	SIP 2.0(RFC-3261)
	Chipset	Broadcom 1190
Key	Key Material	Stainless Steel
	Direct-button	1
	Digital Keyboard	support
Voice	Microphone	1
	Amplifier	0.5W/8Ω
	Speaker	0.5W/8Ω
	Voice Control	Adjustable
	FDSP	Support(AEC)
Voice Flow	Protocol	RTP
	CODEC	G.711, G.729
PORT	Power Supply	12V+-15%/1A DC or PoE
	PoE	PoE 802.3af (Class 0 - 12.95W) 48V/380mA
	LAN	10/100BASE-TX s Auto-MDIX, RJ-45 (Keep press key in 7 seconds to play IP)
	Recommended Cable	HSYV or better
	Passive Switch	Always on and Always close highest at 30V/1A AC/DC
	Active Switched Output	12V/500mA DC
	RS232	Support
RFID/IC Card Reader(Optional)	EM-40XX (125Khz)	Support
	HID Card(125kHz, 26bit)	Not support
	M1 Card (13.56MHz)	Not support
Structure	Shell Material	Aluminum Cover、Plastic back case
	Operating Temperature	-20°C to 70°C
	Working Condition Relative Humidity	10% - 95%
	Storage Temperature	-40°C to 70°C
	Installation	Embedded installation (pre-burying)
	Size	Overall Dimension: 174.5×96×44m pre-burying Mounting Dimension: 148×80×36mm
	Protection Level(Water proof/Damp proof)	IP54

5.1.2. Basic Feature

- Support G.711,G.729 codec.
- Support SIP 2.0(RFC3261) and related RFC.
- Unlock function (swipe or communication)
- Water Proof and Dust Proof;

- Visitor message;
- Calling indoor extension for two-way conversation;
- Software upgrading on line;
- WEB remote management of Terminal malfunction or status;
-

5.1.3. Schematic Diagram



5.2、 Owner Remote Opens the Voice Access Controller by VOIP Phone

- 1) Owner calls the Voice Access Controller by VOIP Terminal.
- 2) the Voice Access Controller answers the call automatically.
- 3) Owner enter Authentication code by VOIP Terminal's keypad to open the door.

5.3、 Card Management

5.3.1 Issue Card Management

(1) Issue <issue administration card>

Input available card number to ID input field, choose Issuer, then press Add to add Issue Administration Card.

The screenshot shows a light blue form titled "Add Administrator". It contains two input fields: "ID" with the value "0003408920" and "Type" with a dropdown menu set to "Issuer". A grey "Add" button is located to the right of the form.

(2) Issue <Delete administration card>

Input available card number to ID input field, choose "Revocation", then press Add to add Delete Administration Card.

The screenshot shows a light blue form titled "Add Administrator". It contains two input fields: "ID" with the value "0003462746" and "Type" with a dropdown menu set to "Revocation". A grey "Add" button is located to the right of the form.

(3) Administration Card List

The screenshot shows a table titled "Administrator Table" with three columns: "ID", "Date", and "Type".

ID	Date	Type
0003408920	December 06 16:47	Issuer
0003462746	December 06 16:48	Revocation

5.3.2 Issue User Card

Issue User Card (method 1):

1) Choose "Card Issuing" in "Door Card".

The screenshot shows a red navigation bar with four buttons: "FUNCTION KEY", "DOOR PHONE", "Door Card", and "Door LOG". Below the navigation bar is a light blue form titled "Card Reader Setting". It contains a "State" dropdown menu set to "Card Issuing" and a grey "Apply" button.

2) Press "Apply" to submit new User Card.

Submit Success
Return

- 3) Put IC card on the Reader Sensing Area, and make sure the reader responded.
- 4) Choose “Normal” in the Card Reader Setting.

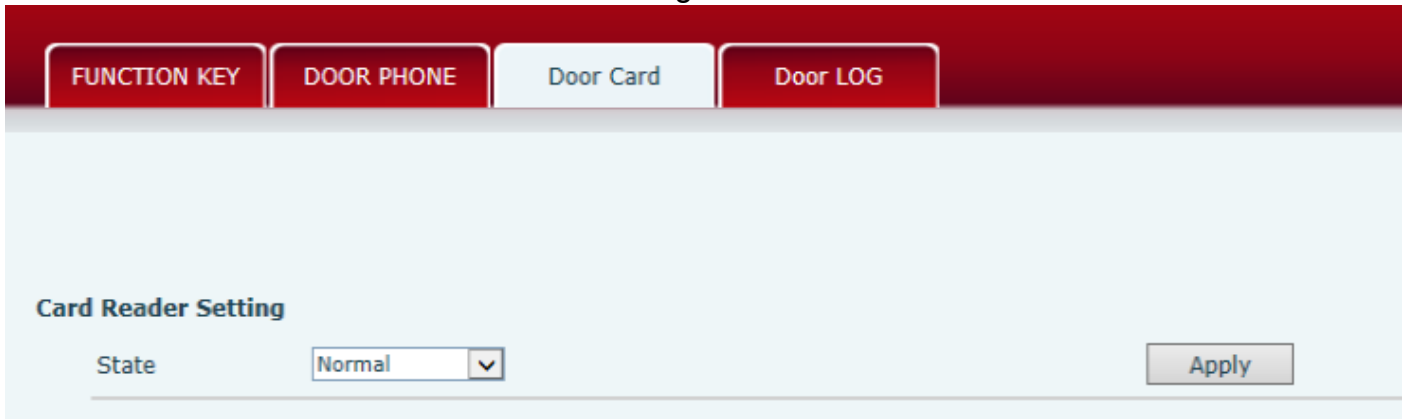

- 5) Press “Apply”.
- 6) You can check the issuing records in “Door Card Table”

Door Card Table

ID	Issuing Date
0004770424	December 06 16:42

Issue the User Card (Method 2):

- 1) Put Issue Administration Card on the Reader Sensing Area, the controller is on the state of issuing.
- 2) Put IC card on the Reader Sensing Area, and make sure the reader responded.
- 3) Put Issue Administration Card on the Reader Sensing Area again to sign out issuing, then the reader is back to the normal state

5.3.3 Delete the user card (Method 1):

- 1) Choose “Card Issuing” in “Door Card”.

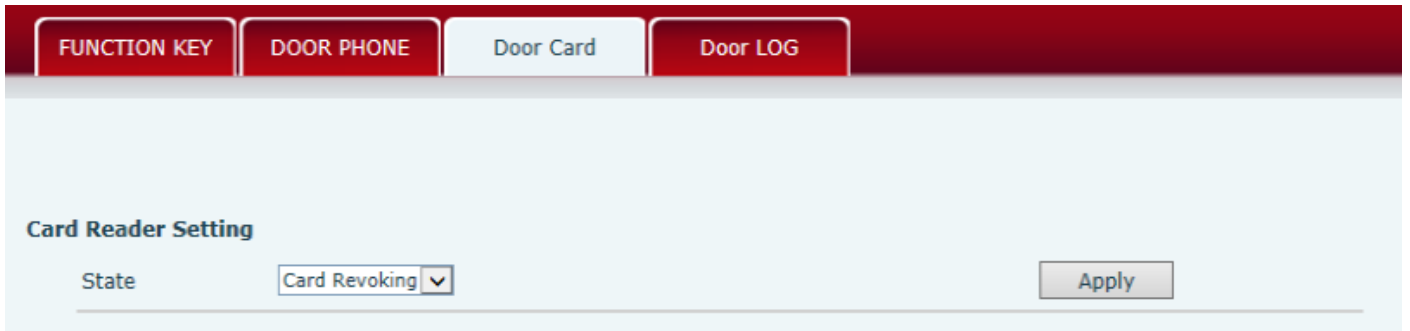

2) Press “Apply” to enter the state of deleting card,

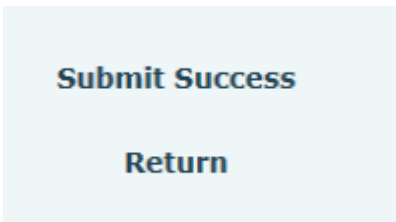

- 3) Put IC card on the Reader Sensing Area, and make sure the reader responded.
- 4) Choose “Normal” in the “Card Reader Setting”.

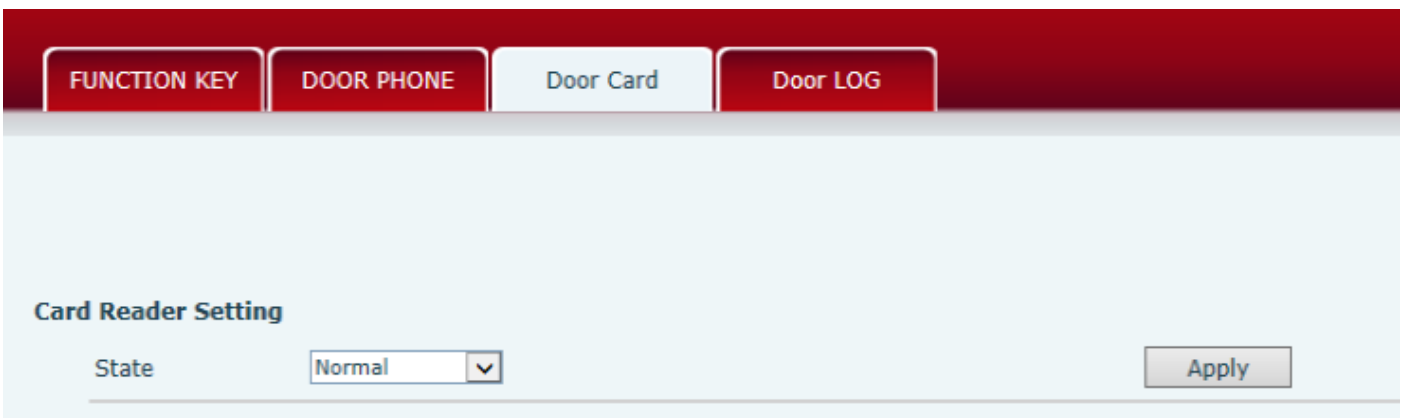

5) Press “Apply” .

Delete the user card (Method 2):

- 1) Put Issue Administration Card on the Reader Sensing Area, the controller is on the state of deleting.
- 2) Put IC card on the Reader Sensing Area, and make sure the reader responded.
- 3) Put Issue Administration Card on the Reader Sensing Area again to sign out deleting, then the reader is back to the normal state.

5.3.4、 Add Remote Visit Data

(1) Add new number

After finish filling accounts, choose the number for the user, press “Add”.

Add Access

Number	<input type="text" value="7289"/>
Access Code	<input type="text" value="800"/>
Name	<input type="text" value="william"/>
Department	<input type="text" value="ODM"/>
Position	<input type="text"/>
ID	<input type="text" value="0004770424"/> ▼
Access Type	<input type="text" value="Guest"/> ▼

Add

(2) Remote Visit Table

Access Table

Number	Access Code	Name	Position	Department	ID	Access Type
7289	800	william	ODM		0004770424	Guest